



**Interconnection System Impact Optional Study Report
Generation Interconnection Request # GI-2016-15**

200 MW Wind Generating Facility
Shortgrass 345 kV Switching Station
Lincoln County, Colorado

Xcel Energy - Transmission Planning West
Xcel Energy
July 18, 2019

Executive Summary

For the GI-2016-15 Optional Study, the GI-2016-15 request is analyzed as a 200 MW wind generation facility that will be located in Lincoln County, Colorado. The primary Point of Interconnection (POI) requested is the 345 kV bus within PSCo's Missile Site 345/230 kV Substation. The facility will connect to the POI via the Rush Creek Gen-Tie with a physical connection to the Gen-Tie at the Shortgrass Switching Station and an approximately 22 mile 345 kV line from Shortgrass to the wind generation facility. The commercial operation date (COD) requested for the generating facility is December 31, 2020 and the assumed back-feed date is September 1, 2020.

Consistent with the GI-2015-16 Interconnection Request, GI-2016-15 was studied for Energy Resource Interconnection Service (ERIS). For the ERIS evaluation, the 200 MW rated output of GI-2016-15 is assumed to be delivered to Public Service Company of Colorado (PSCo) native load, so existing PSCo generation is used as its sink.

This study included, *inter alia*, higher-queued generation, including generation with Large Generator Interconnection Agreements (LGIAs) (active or suspended) and any associated Network Upgrades. While the higher-queued NRIS requests are dispatched at 100% nameplate, the higher-queued ERIS requests are dispatched at 0MW. Higher queued generation interconnected to the Rush Creek Gen-Tie was dispatched at 100%.

The scope of this report includes steady state (power flow) analysis, transient stability analysis, short circuit analysis and scoping level cost estimates. The power flow analysis identifies thermal and voltage violations as a result of the interconnection of the GI. The transient stability analysis verifies that all generating units within the PSCo transmission system and the Affected Systems remain stable (in synchronism), have positive damping and satisfy acceptable dynamic performance criteria. The short circuit analysis determines the maximum available fault current at the POI and identifies if any circuit breaker(s) exceed their breaker duty ratings and need to be replaced.

Based on the studies, a 15 MVAR shunt reactor is needed at Shortgrass Switching Station and 400 MVAR of shunt capacitors are needed at Pronghorn Switching Station to mitigate impacts introduced by the interconnection of GI-2016-15.

The estimated time to site, design, procure and construct the Interconnection Facilities and Network Upgrades is approximately 18 months after authorization to proceed has been obtained.

It is important to note that additional studies may be required following execution of an LGIA to determine how this project may impact integration of other planned generation on the Rush Creek Gen-Tie. These include, but are not limited to Electromagnetic Transients Program (EMTP) studies and Most Severe Single Contingency (MSSC) spinning reserve studies, and the



design studies for an Automatic Volt/Var Setpoint Optimizer (AVSO) control device for all of the wind projects interconnected on the Rush Creek Gen-Tie. With this interconnection request increasing the radial line length to over 190 miles and the total installed capacity on the line to 1600 MW, it is likely the additional studies mentioned above may be required prior to the commercial operation of GI-2016-15.

The total estimated cost of the transmission system improvements required for GI-2016-15 to qualify for ERIS is \$14.754 Million (Tables 2 and 3).

The ERIS results above are contingent upon the mitigation of all overloads and Network Upgrades identified in the Affected Systems and the PSCo system, and Network Upgrades identified for all applicable higher-queued Interconnection Requests

If there is a change in status of one or more higher-queued Interconnection Requests due to withdrawal from the queue or changing from NRIS to ERIS, and the Network Upgrades identified for the higher queued Interconnection Requests are not constructed, the Network Upgrade costs would become the responsibility of GI-2016-15 to the extent they are necessary to interconnect GI-2016-15. A restudy will be performed as needed to identify the new Network Upgrade responsibilities.

For GI-2016-15 interconnection:

ERIS (after required transmission system improvements) = 200 MW (output delivery assumes the use of existing firm or non-firm capacity of the PSCo Transmission System on as-available basis)

Note: ERIS, in and of itself, does not convey transmission service.

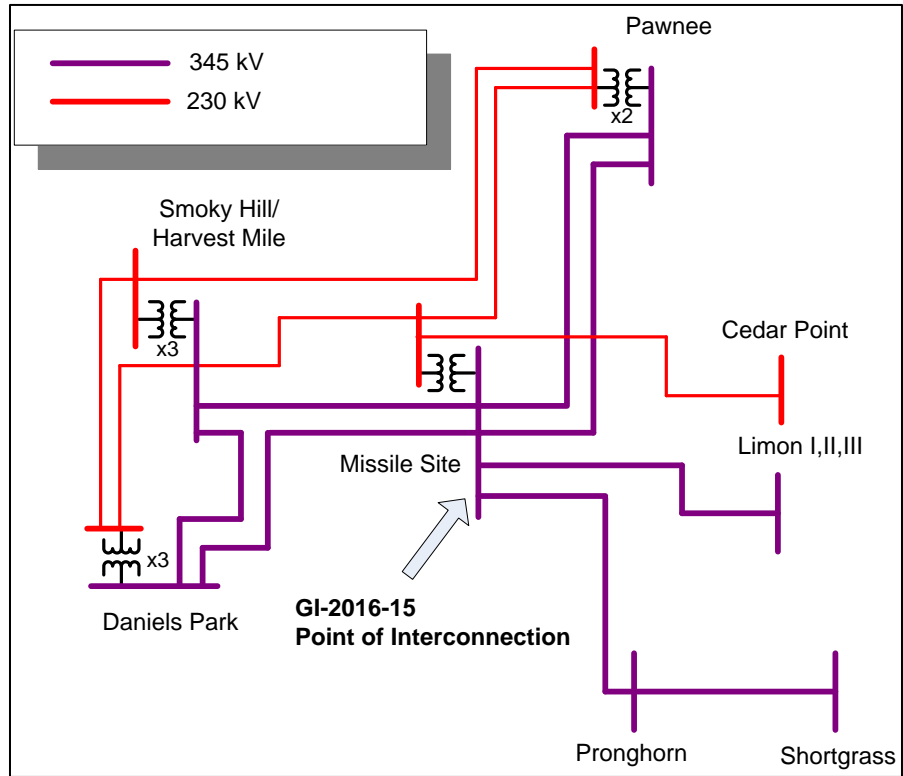

Figure 1 - GI-2016-15 Point of Interconnection and Study Area

Introduction

GI-2016-15 is a 200 MW wind generation facility that will be located in Lincoln County, Colorado. The Generating Facility (GF) will be made up of approximately sixty (60) Vestas 3.45 MW, 0.90 PF wind turbines, each with its own 660V/34.5kV, 2800 kVA, Z=6.0% pad-mounted step-up transformer. The 34.5 kV collector system will connect to two (2) 34.5/345 kV, 68/90/112 MVA, Z=8.5% main step-up transformers, which in turn will interconnect to the Missile Site 345 kV Primary Point of Interconnection (POI) via the Missile Site – Rush Creek 345kV Gen-Tie and the Interconnection Customer’s approximately 22 mile 345 kV gen – tie line.

The main purpose of this Interconnection System Impact Optional Study is to determine the system impact of interconnecting 200 MW of wind generation at the Missile Site 345 kV POI. As per the Interconnection Study Request, GI-2016-15 was studied for Energy Resource Interconnection Service (ERIS)¹. For the ERIS evaluation, the 200 MW rated output of GI-2016-15 is assumed to be delivered to PSCo network load, so existing PSCo generation is used as its sink.

No Affected Systems for this GI were identified.

Study Scope and Analysis Criteria

The scope of this report includes steady state (power flow) analysis, transient stability analysis, short circuit analysis and scoping level cost estimates. The power flow analysis identifies thermal and voltage violations in the PSCo system and the Affected Systems as a result of the interconnection of the GI. Several single contingencies were studied. The transient stability analysis verifies that all generating units within the PSCo transmission system and the Affected Systems remain stable (in synchronism), have positive damping and satisfy acceptable dynamic performance criteria. The short circuit analysis determines the maximum available fault current at the POI and identifies if any circuit breaker(s) within the PSCo station(s) exceed their breaker duty ratings and need to be replaced.

PSCo adheres to applicable NERC Reliability Standards and Western Electricity Coordinating Council (WECC) Reliability Criteria, as well as its internal transmission planning criteria for studies. The steady state analysis criteria are as follows:

P0 - System Intact conditions:

Thermal Loading: $\leq 100\%$ of the normal facility rating

Voltage range: 0.95 to 1.05 per unit

P1-P2 – Single Contingencies:

Thermal Loading: $\leq 100\%$ Normal facility rating

¹ Energy Resource Interconnection Service shall mean an Interconnection Service that allows the Interconnection Customer to connect its Generating Facility to the Transmission Provider’s Transmission System to be eligible to deliver the Generating Facility’s electric output using the existing firm or non-firm capacity of the Transmission Provider’s Transmission System on an as available basis. Energy Resource Interconnection Service in and of itself does not convey transmission service.



Voltage range: 0.90 to 1.10 per unit
Voltage deviation: $\leq 8\%$ of pre-contingency voltage

The study area is the electrical system consisting of PSCo's transmission system and the affected party's transmission system that is impacted or that will impact interconnection of GI-2016-15. The study area for GI-2016-15 includes WECC designated areas 70 (PSCOLORADO) and 73 (WAPA R.M.).

Transient stability criteria require that all generating machines remain in synchronism and all power swings should be well damped following a contingency event. Also, transient voltage performance should meet the following WECC Disturbance-Performance criteria:

- Following fault clearing, the voltage shall recover to 80% of the pre-contingency voltage within 20 seconds for all contingencies
- For all contingencies, following fault clearing and voltage recovery above 80%, voltage at each applicable BES bus serving load shall neither dip below 70% of pre-contingency voltage for more than 30 cycles nor remain below 80% of pre-contingency voltage for more than two seconds.
- For contingencies without a fault, voltage dips at each applicable BES bus serving load shall neither dip below 70% of pre-contingency voltage for more than 30 cycles nor remain below 80% of pre-contingency voltage for more than two seconds

Cumulative Power Flow Case Creation

The Base Case used for the power flow analysis originated from the 2023HS case built for the TPL Studies Work Group of the Colorado Coordinated Planning Group (CCPG). The 2023HS case was built in 2018, and as part of the case build effort for the TPL Studies Work Group, the case has been reviewed by PSCo and the neighboring utilities within the CCPG foot print. PSCo then made the following changes to the 2023HS case to create the Base Case.

All transmission planned projects in PSCo's 10 year transmission plan (http://www.oasis.oati.com/woa/docs/PSCO/PSCODocs/Q1_2019_Transmission_Plan.pdf) that are expected to be in-service before July 2023 are modeled in the Base Case, consistent with the case season and year. This includes the following projects:

- Shortgrass 345kV Switching Station – ISD 2020
- Shortgrass – Cheyenne Ridge 345kV line – ISD 2020
- Graham Creek 115kV Substation – ISD 2021
- Husky 230/115kV Substation – ISD 2021
- Cloverly 115kV Substation – ISD 2021
- Ault – Husky 230kV line – ISD 2021
- Husky - Graham Creek – Cloverly 115kV line – ISD 2021
- Monument – Flying Horse 115kV Series Reactor – ISD 2021

- Gilman – Avon 115kV line – ISD 2022
- Upgrade Villa Grove – Poncha 69kV Line – ISD 2021
- Upgrade Poncha – San Luis Valley 115kV line – ISD 2021

The following PSCo terminal equipment upgrade operational and maintenance projects for which PSCo has plans to increase the line ratings have been modeled at their future ratings in the Base Case:

- Waterton – Martin2 tap 115kV line was modeled at 189MVA
- Malta – Twin Lakes 115kV line was modeled at 143MVA
- Twin Lakes – Otereo 115kV line was modeled at 143MVA
- Otereo – Buena Vista 115kV line was modeled at 150MVA
- Buena Vista – Ray Lewis 115kV line was modeled at 136MVA
- Ray Lewis – Poncha 115kV line was modeled at 164MVA
- Arapahoe – SantaFe – Daniels Park 230kV line was modeled at 560MVA
- Daniels Park – Prairie1 230kV line was modeled at 576MVA
- Greenwood – Monaco 230kV line was modeled at 503MVA
- Leetsdale – Monaco 230kV line was modeled at 470MVA
- Poncha – Smelter town 115kV line was modeled at 114MVA
- San Luis Valley – Sargent 115kV line was modeled at 120MVA

Planned reactive power devices for integration of the Colorado Energy Plan around Missile Site were included in the WECC base case. This included the following reactive devices:

- Shortgrass 60 MVAR shunt reactor
- Pronghorn +/- 150 MVAR STATCOM
- Missile Site 360 MVAR shunt capacitor
- Harvest Mile 240 MVAR shunt capacitor
- Daniels Park 120 MVAR shunt capacitor

The Base Case also modeled the Sargent – Poncha 115kV line closed.

The following additional changes were made to TSGT model in the Base Case per further review and comment from TSGT:

- 30MW San Isabel Solar tapping Ludlo Tap – Pinon Canyon 115kV line
- 80MW TSGT_0809 solar facility tapping Gladstone – Walsenburg 230kV line
- 80MW TSGT_STEM_PV solar facility at Stem Beach 115kV bus
- Fuller – Vollmer – Black Squirrel 115 kV line modeled at 173 MVA

The following additional changes were made to BHE model in the Base Case per further review and comment from BHE:

- Fountain Valley – DesertCove 115kV line was modeled at 171MVA. Planned upgrade project in 1/2021

- Fountain Valley – MidwayBR 115kV line was modeled at 171MVA. Planned upgrade project in 1/2021
- Pueblo West Substation – ISD 1/2021
- Skyline Ranch Substation – ISD 10/2021
- West Station – Greenhorn 115kV line Rebuild – ISD 9/2022

The following additional changes were made to CSU model in the Base Case per further review and comment from CSU:

- The Cottonwood – Tesla 34.5kV line is modeled open and Kettle Creek – Tesla 34.5kV line is modeled closed on the CSU system
- Grazing Yak Solar – ISD 2020
- Cottonwood 230/115kV auto-transformer replacement – ISD 2019
- Nixon – Kelker 230kV line upgrade – ISD 2019

The Base Case model includes existing PSCo generation resources at the time of this study.

The Base Case was updated to include higher-queued generation with LGIAs (active or suspended) and their associated Network Upgrades that were not included in the initial Base Case. In addition, all higher-queued generation in the current PSCo GIR queue and their associated upgrades are modeled. The higher-queued LGIAs modeled are GI-2009-8, GI-2010-8, GI-2014-2, GI-2014-12, GI-2014-13 and GI-2014-14. The higher-queued GIRs modeled are: GI-2014-6, GI-2014-8, GI-2014-9, GI-2014-12, GI-2016-4, GI-2016-7, GI-2016-9, GI-2016-12, GI-2016-13, and GI-2016-14. While the higher-queued NRIS requests are dispatched at 100% nameplate, the higher-queued ERIS requests are dispatched at 0MW. Higher queued generation interconnected to the Rush Creek Gen-Tie was dispatched at 100%.

The following PSCo Network Upgrades identified in the higher-queued GIs are modeled in the GI-2016-15 Base Case:

- MidwayPS 230/115kV, 100MVA transformer replaced with 150MVA unit – Network Upgrade assigned to GI-2014-12
- Increase Greenwood – Prairie3 230kV line rating to 637MVA – Network Upgrade assigned to GI-2016-7
- Increase Daniels Park – Fuller 230kV line rating to 577MVA – Network Upgrade assigned to GI-2016-7
- Increase Ray Lewis – Buena Vista Tap 115kV line rating to 150MVA – Network Upgrade assigned to GI-2016-9
- Increase Daniels Park – Prairie3 230kV line rating to 797MVA – Network Upgrade assigned to GI-2016-9
- Increase Daniels Park – Prairie1 230kV line rating to 797MVA – Network Upgrade assigned to GI-2016-9
- Increase Daniels Park – Fuller 230kV line rating to 802MVA – Network Upgrade assigned to GI-2016-9

- Increase Greenwood – Prairie1 230kV line rating to 637MVA – Network Upgrade assigned to GI-2016-9
- Increase Greenwood – Monaco 230kV rating to 637MVA – Network Upgrade assigned to GI-2016-9

The generation dispatch in the WECC base case was adjusted to create heavy generation in the Pawnee – Missile Site – Smoky Hill – Daniels Park transmission system. This was accomplished by adopting the generation dispatch given in Table 7.

For the power flow analysis, the Study Case for GI-2016-15 was created by adding the GI-2016-15 model to the Benchmark Case. The 200 MW output from GI-2016-15 was balanced to PSCo units outside the study area within the Denver Metro Area.

A power flow analysis was performed and the results of the Benchmark Case and Study Case were compared to determine the impacts of the interconnection of GI-2016-15.

The steady state analysis was performed using PTI's PSSE Ver. 33.6.0 program and the ACCC contingency analysis tool.

Transient stability analysis was performed using General Electric's PSLF Ver.21.0_02 program. A study case was created by modeling GI-2016-15 in the 2023HS case. Three phase faults were simulated for selected single and multiple contingencies using standard clearing times. PSLF's DYTOOLS EPCL program was used to simulate the disturbances.

Power Flow Analysis Results

The results of the single contingency analysis (P1 and P2) are given in Table-5. The following overloads were seen due to the additional 200 MW injection from GI-2016-15. No network upgrades for delivery were assigned to GI-2016-15 to qualify for ERIS.

- Waterton – Martin1TP 115kV line loading increased from 111.7% to 117.2%
- Allison – Soda Lake 115kV line loading increased from 99.5% to 105.0%
- Havana1 – Chambers 115kV line loading increased from 93.2% to 102.0%.
- Leetsdale – Monaco12 230KV line loading increased from 92.1% to 104.6%

The steady-state power flow analysis determined reactive support required for the interconnection to operate within appropriate voltage limits. Under no load conditions on the Rush Creek Gen-Tie a 15 MVAR shunt reactor was necessary at Shortgrass Switching Station to maintain required voltage on the Gen-Tie. Under heavy loading conditions on the Rush Creek Gen-Tie a 270 MVAR shunt capacitor was necessary to meet reactive requirements at Pronghorn Switching Station. The placement of these reactive support devices is the more economical option and more effectively interacts with planned reactive support upgrades in the area.

Voltage Regulation and Reactive Power Capability

Interconnection Customer is required to interconnect its Large Generating Facility with Public Service of Colorado's (PSCo) Transmission System in accordance with the *Xcel Energy Interconnection Guidelines for Transmission Interconnected Producer-Owned Generation Greater Than 20 MW* (available at:

<http://www.transmission.xcelenergy.com/staticfiles/microsites/Transmission/Files/PDF/Interconnection/Interconnections-POL-TransmissionInterconnectionGuidelineGreat20MW.pdf>).

In addition, any wind generating plant interconnections must also fulfill the performance requirements specified in FERC Order 661-A. Accordingly, the following voltage regulation and reactive power capability requirements at the POI are applicable to this interconnection request:

- To ensure reliable operation, all Generating Facilities interconnected to the PSCo transmission system are expected to adhere to the *Rocky Mountain Area Voltage Coordination Guidelines (RMAVCG)*. Accordingly, since the POI for this interconnection request is located within Southeast Colorado - Region 4 defined in the *RMAVCG*; the applicable ideal transmission system voltage profile range is 1.02 – 1.03 per unit at regulated buses and 1.0 – 1.03 per unit at non-regulated buses.
- Xcel Energy's OATT (Attachment N effective 10/14/2016) requires all non-synchronous Generator Interconnection (GI) Customers to provide dynamic reactive power within the power factor range of 0.95 leading to 0.95 lagging at the high side of the generator substation. Furthermore, Xcel Energy requires every Generating Facility to have dynamic voltage control capability to assist in maintaining the POI voltage schedule specified by the Transmission Operator as long as the Generating Facility does not have to operate outside its 0.95 lag – 0.95 lead dynamic power factor range capability.
- It is the responsibility of the Interconnection Customer to determine the type (switched shunt capacitors and/or switched shunt reactors, etc.), the size (MVAR), and the locations (34.5kV or 230kV bus) of any additional static reactive power compensation needed within the generating plant in order to have adequate reactive capability to meet the +/- 0.95 power factor and the 1.02 – 1.03 per unit voltage range standards at the POI. Further, for wind generating plants to meet the LVRT (Low Voltage Ride Through) performance requirements specified in FERC Order 661-A, an appropriately sized and located dynamic reactive power device (DVAR, SVC, etc.) may also need to be installed within the generating plant. Finally, it is the responsibility of the Interconnection Customer to compensate their generation tie-line to ensure minimal reactive power flow under no load conditions.

The Interconnection Customer is required to demonstrate to the satisfaction of PSCo Transmission Operations prior to the commercial in-service date of the generating plant that it can safely and reliably operate within the required power factor and voltage ranges (noted above).

Transient Stability Study Results

The transient stability analysis for GI-2016-15 System Impact Study simulated nine disturbances for the study case (power flow case with GI-2016-15 modeled). The analysis assumed the additional reactive power support identified as part of the power flow analysis as in-service.

It is determined that GI-2016-15 generation produced some adverse system stability impact. The following results were obtained for every case and disturbance analyzed:

- No machines lost synchronism with the system
- Transient voltage drop violations were observed
- Machine rotor angles displayed unacceptable negative or zero damping

The transient stability analysis determined that the loss of the Missile Site – Smoky Hill and Missile Site – Daniels Park 345 kV double circuit tower line displayed negative or zero damping with maximum transient voltage dips outside acceptable dynamic performance criteria as compared to the Benchmark Case. The analysis determined an additional 130 MVAR shunt capacitor at Pronghorn Switching Station (on top of the 270 MVAR capacitor identified in the power flow analysis) was required to alleviate stability concerns. The resulting shunt capacitor requirement at Pronghorn was 400 MVAR, comprised in four 100 MVAR steps to alleviate voltage swings during capacitor switching. Transient stability plots showing surrounding bus voltages, bus frequencies, generator terminal voltages, generator relative angles, generator speeds, and generator power output for selected disturbances run for each study scenario have been created and documented in the Appendix.

It is the responsibility of the Interconnection Customer to ensure that its generating facility is capable of meeting the voltage ride-through and frequency ride-through (VRT and FRT) performance specified in the NERC Reliability Standard PRC-024.

Short Circuit and Breaker Duty Analysis

The calculated short circuit levels and Thevenin system equivalent impedances at the Missile Site 345 kV POI are tabulated in Table 1 below.

Table 1 – Short Circuit Parameters at the GI-2016-15 Missile Site 345 kV bus POI

	Before GI-2016-15 Interconnection	After GI-2016-15 Interconnection
Three Phase Current	21751A	21496A
Single Line to Ground Current	17814A	17673A
Positive Sequence Impedance	0.722+j9.186 ohms	0.742+j9.295 ohms
Negative Sequence Impedance	0.766+j9.179 ohms	0.787+j9.288 ohms
Zero Sequence Impedance	3.284+j15.025 ohms	3.290+j15.075 ohms

A preliminary breaker duty study did not identify any circuit breakers that became “over-dutied”² as a result of adding this generation. The study assumes the facility rating upgrades required for network delivery of prior queued generation would result in negligible changes in the impedance of associated elements.

Costs Estimates and Assumptions

The Transmission Provider has specified and estimated the cost of the equipment, engineering, procurement and construction work needed to interconnect GI-2016-15. The results of the engineering analysis for facilities owned by the Transmission Provider are estimates and are summarized in Tables 2 and 3. Note that all required upgrades are on the customer side of the Point of Interconnection and thus do not conform to the definition of a Network Upgrade under the *pro forma* LGIA. Nothing in this report presupposes the appropriate allocation of costs for specific facilities and a non-conforming LGIA may need to be filed with FERC due to the unique aspects of this interconnection request.

Table 2: “Transmission Provider’s Interconnection Facilities” includes the nature and estimated cost of the Transmission Provider’s Interconnection Facilities and an estimate of the time required to complete the construction and installation of such facilities.

Table 3: “Reactive Support Upgrades required for” includes the nature and estimated cost of reactive support upgrades necessary to accomplish the interconnection and an estimate of the time required to complete the construction and installation of such facilities.

Upgrades identified in Tables 2 and 3 are illustrated in Figure 1 in the Appendix which shows the physical and electrical connection of the Interconnection Customer’s Generating Facility to the Transmission Provider’s Transmission System. The one-line diagram also identifies the

² “Over-dutied” circuit breaker: A circuit breaker whose short circuit current (SCC) rating is less than the available SCC at the bus.



electrical switching configuration of the interconnection equipment, including, without limitation: the transformer, switchgear, meters, and other station equipment.

Other Potential Studies

PSCo has undertaken further studies to integrate the planned generation on the Rush Creek Gen-Tie to which is outside the scope of this System Impact Optional Study. Three wind projects (GI-2016-3, GI-2016-4, and GI-2016-14) are planned to be interconnected to the radial Rush Creek Gen-Tie. The wind projects consist of five collector sites spread across approximately 170 miles of radial transmission. Additional studies that have been completed or are on-going to integrate the planned generation include Electromagnetic Transients Program (EMTP) studies and Most Severe Single Contingency (MSSC) spinning reserve studies. The EMTP studies determine the expected voltage swings during switching events and wind plant control interactions to guide equipment facility ratings and plant control design. The MSSC spinning reserve studies determine if the Northwest Power Pool and PSCo can provide enough spinning reserve operationally required for the potential MSSC.

With this interconnection request increasing the radial line length to over 190 miles and the total installed capacity on the line to 1600 MW, it is likely that additional studies like those mentioned above will be required after execution of an LGIA and prior to the commercial operation of GI-2016-15. PSCo is also in the process of designing an Automatic Volt/Var Setpoint Optimizer (AVSO) control device for the wind projects on the Rush Creek Gen-Tie and the reactive support devices in the area in which GI-2016-15 will likely have to participate.

Conclusion

The total estimated cost of the transmission system improvements required for GI-2016-15 to qualify for ERIS is \$14.754 Million (Tables 2 and 3)

For GI-2016-15 interconnection:

ERIS (after required transmission system improvements) = 200 MW (output delivery assumes the use of existing firm or non-firm capacity of the PSCo Transmission System on as as-available basis).

Note: ERIS, in and of itself, does not convey transmission service.

Table 2 –Transmission Provider’s Interconnection Facilities

Element	Description	Cost Est. (Millions)
PSCo’s Shortgrass 345 kV Bus	Interconnect Customer to physically tap at the Shortgrass 345kV substation, with a point of interconnection on the Missile 345kV bus. The new equipment includes: <ul style="list-style-type: none"> • Two 345kV 3000A breakers • Three 345kV 3000A disconnect switches • Three 345kV arresters • Two 2000A wave traps • One set (of three) high side metering units • Fiber communication equipment • Station controls • Associated electrical equipment, bus, wiring and grounding • Associated foundations and structures <ul style="list-style-type: none"> • Associated transmission line communications, fiber, relaying and testing. 	\$2.871
	Transmission line tap into substation.	\$0.055
	Siting and Land Rights support for siting studies, land and ROW acquisition and construction	\$0.020
	Total Cost Estimate for Transmission Provider’s Interconnection Facilities	\$2.946
Time Frame	Site, design, procure and construct	18 Months

Table 3 - Reactive Support Upgrades for Interconnection

Element	Description	Cost Estimate (Millions)
PSCo's Shortgrass 345 kV Bus	Add a 15MVAR reactor on the 345kV bus at PSCo's 345kV Shortgrass substation. The new equipment includes: <ul style="list-style-type: none"> • Five 345kV 3000A breakers • One 345kV 15MVAR reactor • Seven 345kV 3000A disconnect switches • Station controls • Associated electrical equipment, bus, wiring and grounding • Associated foundations and structures • Associated fiber, reactor differential relaying and testing. 	\$5.129
PSCo's Pronghorn 345 kV Bus	Add a 400MVAR capacitor bank in four 100MVAR stages at PSCo's 345kV Pronghorn substation in a new ring position. The new equipment includes: <ul style="list-style-type: none"> • Six 345kV 3000A breakers • Four 345kV 100MVAR capacitor bank • Seven 345kV 2000A disconnect switches • Station controls • Associated electrical equipment, bus, wiring and grounding • Associated foundations and structures • Associated fiber, reactor differential relaying and testing. 	\$6.679
	Siting and Land Rights support for Substation Construction:	0.000
	Total Cost Estimate for Reactive Support Upgrades	\$11.808
Time Frame	Site, design, procure and construct	18 Months

Cost Estimate Assumptions

- Scoping level cost estimates for Interconnection Facilities and Network Upgrades have a specified accuracy of +/- 30%.
- Estimates are based on 2019 dollars (appropriate contingency and escalation applied, AFUDC is not included).
- Labor is estimated for straight time only – no overtime included.
- Lead times for materials were considered for the schedule.
- Estimates are developed assuming typical construction costs for previous completed projects. These estimates include all applicable labor and overheads associated with the siting support, engineering, design, material/equipment procurement, construction, testing and commissioning of these new substation and transmission line facilities.
- The Generation Facility is not in PSCo's retail service territory. Therefore, no costs for retail load metering are included in these estimates.
- PSCo (or its Contractor) crews will perform all construction, wiring, and testing and commissioning for PSC owned and maintained facilities.

- The estimated time to site, design, procure and construct the upgrades required for Interconnection is approximately 18 months after authorization to proceed has been obtained.
- A CPCN will not be required for the interconnection facilities construction.
- Line and substation bus outages will be necessary during the construction period. Outage availability could potentially be problematic and necessitate extending the back-feed date.
- Estimates do not include the cost for any Customer owned equipment and associated design and engineering.
- The Customer will be required to design, procure, install, own, operate and maintain a Load Frequency/Automated Generation Control (LF/AGC) RTU at the Customer Substation. PSCo / Xcel will need indications, readings and data from the LFAGC RTU.
- Power Quality Metering (PQM) will be required on the Customer's 345 kV line terminating into the Shortgrass Switching Station.
- Customer will string optical ground wire (OPGW) cable into the substation as part of their transmission line construction scope.

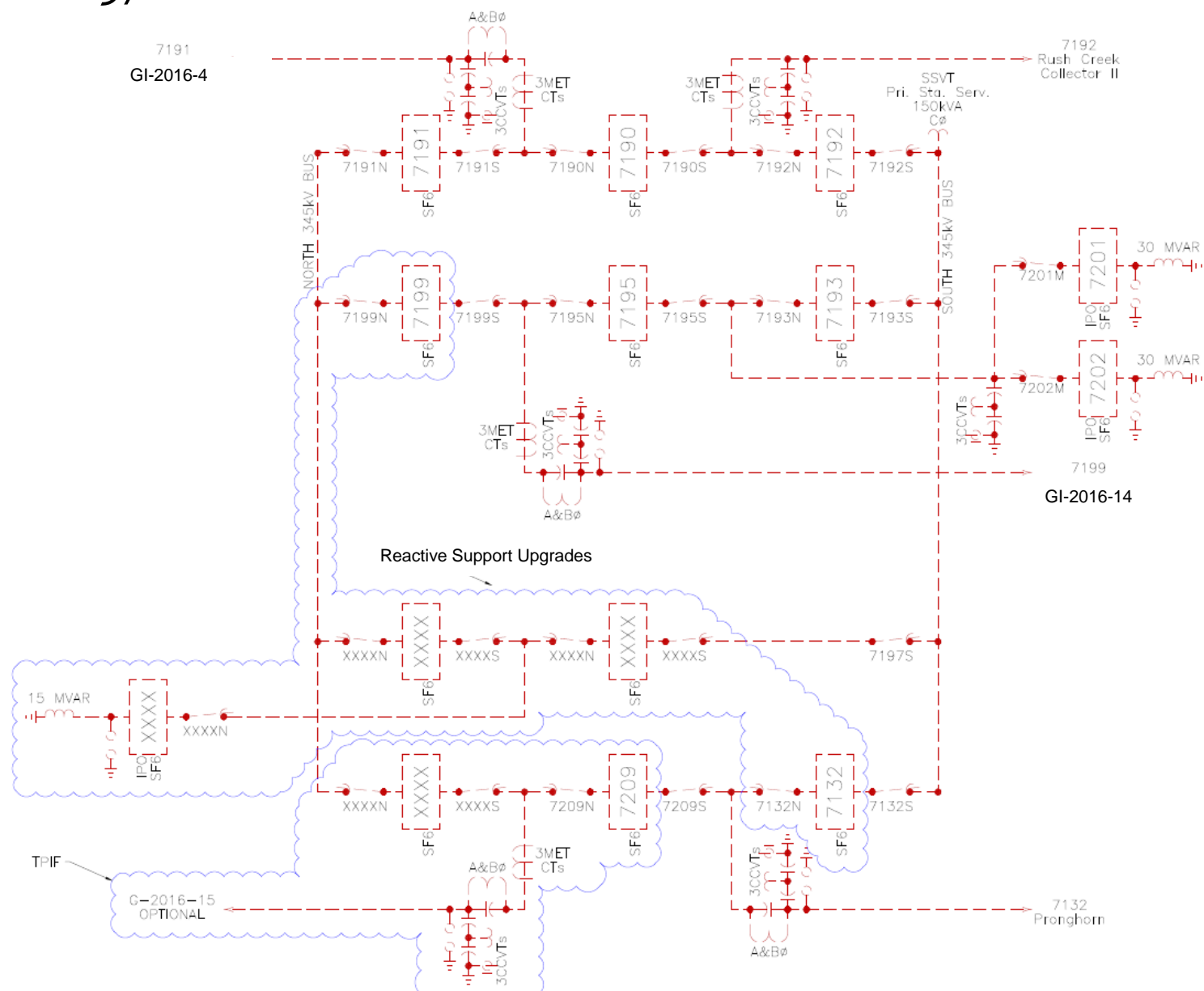

Figure 1 – Preliminary one-line of GI-2016-15 connection within the Shortgrass 345 kV Switching Station

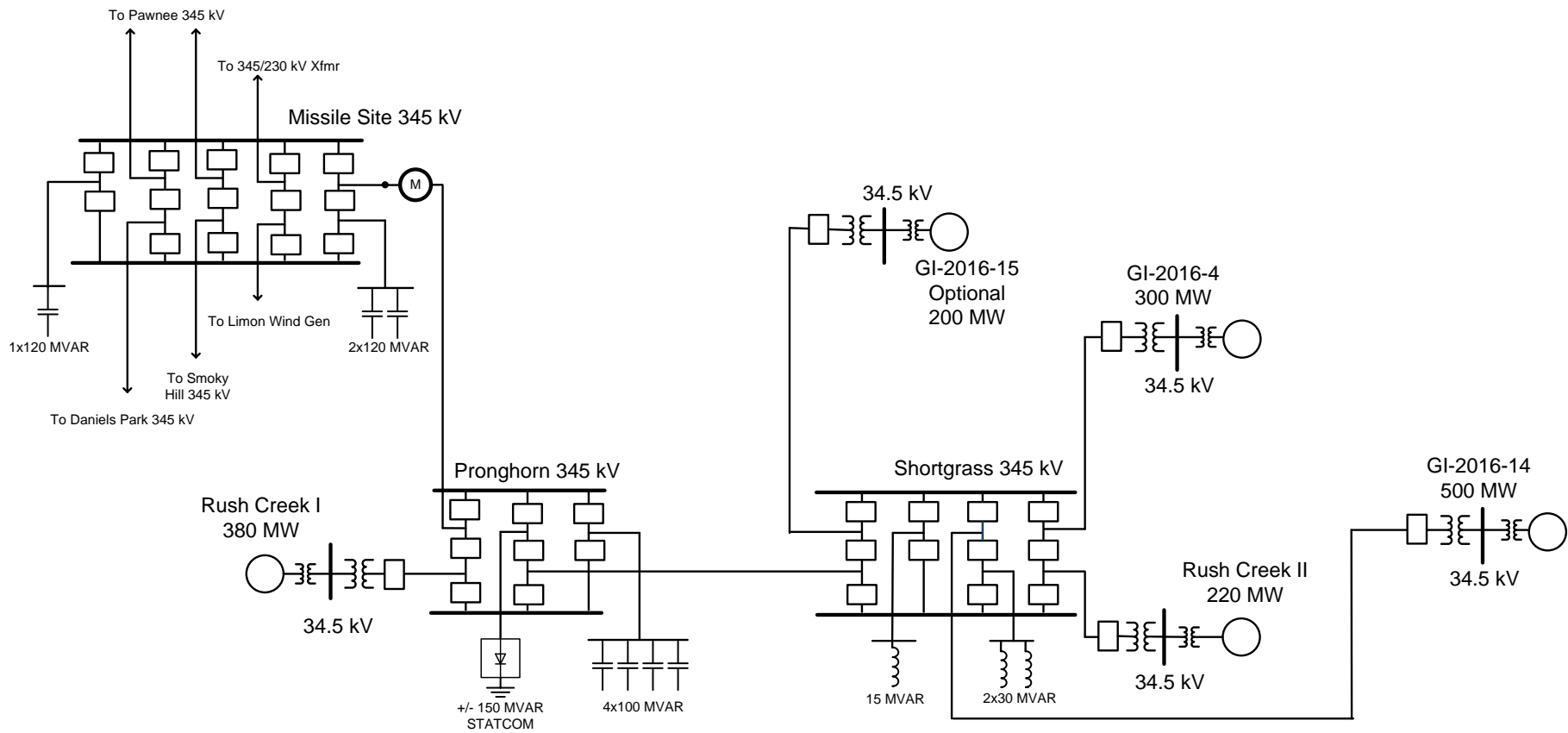

Figure 2 – Simplified diagram of the planned Rush Creek Gen-Tie including GI-2016-15 (does not show all transmission equipment)



Table-5 Power Flow Analysis Results

Note – Thermal overloads due to GI-2016-15 for single contingencies are calculated using the normal rating of the facility. All overloads are in red.

Table 5 – Summary of Thermal Violations from Single Contingency Analysis

				Facility Loading Without GI-2016-15		Facility Loading With GI-2016-15			
Monitored Facility (Line or Transformer)	Type	Owner	Branch Rating MVA (Norm)	N-1 Flow MVA (Norm)	N-1 Flow % of Rating (Norm)	N-1 Flow MVA (Norm)	N-1 Flow % of Rating (Norm)	% Change	NERC Single Contingency
Allison – SodaLake 115kV	Line	PSCO	153	174	114%	184	120.3%	6.3%	Waterton – Martin1 Tap 115kV
Buckly34 – Smokyhill 230kV	Line	PSCo	576	573	101.1%	629	112.0%	10.9%	Greenwood – Monaco 230kV
Buckly34 – Tolgate 230kV	Line	PSCo	576	574	101.1%	625	112.0%	10.9%	Greenwood – Monaco 230kV
DeerCreek – Soda Lake	Line	PSCo	120	116	96.7%	130	107.5%	10.8%	Chatfield - Waterton 230kV
Derby_2 – Havana1	Line	PSCo	120	120	99.3%	136	111.7%	12.4%	Havana – Chambers 115kV
Elati1 – MonroePS 230kV	Line	PSCo	398	485	124.2%	525	135.8%	11.6%	Daniels Park - Santa Fe 230kV
Denver Terminal – Elati 1 230kV	Line	PSCo	435	397	93.0%	436	103.4%	10.4%	Daniels Park - Santa Fe 230kV
Greenwood – Monaco12 230kV	Line	PSCo	637	683	108.5%	756	121.3%	12.8%	Buckly - Smoky Hill 230kV
HarrisPS – Leetsdale2 115kV	Line	PSCo	141	170	120.1%	227	159.4%	39.3%	Leetsdale – Monroe 230kV
Havana1 – Chambers 115kV	Line	PSCo	120	150	123.4%	166	135.5%	12.1%	Havana2 – Chamber 115kV
Havana2 – Chambers 115kV	Line	PSCo	159	147	91.3%	160	100.1%	8.8%	Havana1 – Chambers 115kV
Jewell2 – Tolgate 230kV	Line	PSCo	484	475	100.1%	529	112.8%	12.7%	Greenwood – Monaco12 230kV
Leetsdale – MonroePS 230kV	Line	PSCo	500	556	113.1%	595	122.5%	9.4%	Daniels Park – Sante Fe 230kV
Leetsdale – Monaco12 230kV	Line	PSCo	503	644	129.5%	717	145.7%	16.2%	Buckly – SmokyHill 230kV
Littleton1 – Martin1TP 115kV	Line	PSCo	159	152	97.6%	162	103.5%	5.9%	Arapahoe – Arapahoe B (T5)
Pawnee – Story 230kV	Line	PSCo	581	572	98.3%	705	123.4%	25.1%	Pawnee – Ft Lupton 230kV

Table 5 – Summary of Thermal Violations from Single Contingency Analysis

				Facility Loading Without GI-2016-15		Facility Loading With GI-2016-15			
Monitored Facility (Line or Transformer)	Type	Owner	Branch Rating MVA (Norm)	N-1 Flow MVA (Norm)	N-1 Flow % of Rating (Norm)	N-1 Flow MVA (Norm)	N-1 Flow % of Rating (Norm)	% Change	NERC Single Contingency
SmokyHill – Strasburg 115kV	Line	PSCo	118	121	101.0%	128	106.4%	5.4%	Quincy – Brickcenter 230KV
Waterton – Martin1TP 115kV	Line	PSCo	138	177	127.6%	188	134.3%	6.7%	Arapahoe – Arapahoe B (T5)

Table-6 Transient Stability Analysis Results

Stability Scenarios						
#	Fault Location	Fault Type	Facility Tripped	Clearing Time (cycles)	Post-Fault Voltage Recovery	Angular Stability
1	Missile Site 345kV	3ph	Missile Site – Pronghorn 345 kV Line	Primary (6.0)	Maximum transient voltage dips within criteria	Stable with positive damping
2	Missile Site 345kV	3ph	Missile Site –Smoky Hill 345 kV Line	Primary (6.0)	Maximum transient voltage dips within criteria	Stable with positive damping
3	Missile Site 345kV	3ph	Missile Site – Pawnee 345 kV Line	Primary (6.0)	Maximum transient voltage dips within criteria	Stable with positive damping
4	Missile Site 345kV	3ph	Missile Site – Daniels Park 345 kV Line	Primary (6.0)	Maximum transient voltage dips within criteria	Stable with positive damping
5	Missile Site 345kV	3ph	Missile Site 230 / 345 kV Transformer	Primary (6.0)	Maximum transient voltage dips within criteria	Stable with positive damping
6	Ault 345kV	3ph	Craig – Ault 345 kV Line	Primary (6.0)	Maximum transient voltage dips within criteria	Stable with positive damping
7	Comanche 34.5kV	3ph	Comanche Unit 3	Primary (6.0)	Maximum transient voltage dips within criteria	Stable with positive damping
8	Missile Site 345kV	3ph	Missile Site – Smoky Hill & Missile Site – Daniels Park 345 kV Lines	Primary (6.0)	Unstable	Stable with positive damping
9	Missile Site 345kV	3ph	Missile Site – Pawnee #1 & #2 345 kV Lines	Primary (5.0)	Maximum transient voltage dips within criteria	Stable with positive damping

Table 7 – Generation Dispatch in the Study area (MW is Gross Capacity)

PSCo:

<u>Bus</u>	<u>Gen ID</u>	<u>MW</u>
Cedar Point	W1	200
GI-2016-4	W1	301
GI-2016-15	W1	500
Limon 1	W1	160
Limon 2	W2	160
Limon 3	W3	160
Manchief	G1	126
Manchief	G2	126
Pawnee	C1	536
Peetz Logan	W1	160
Peetz Logan	W2	96
Peetz Logan	W3	63.6
Peetz Logan	W4	140
Rush Creek I	W1	400
Rush Creek II	W2	200
Titan Solar	S1	42.5



Appendix – Transient Stability Plots

Plots shown below are bus voltage, bus frequency, generator angle, generator terminal voltage, generator speed, and generator power for the following selected disturbances. Other plots are available upon request.

- Missile Site – Smoky Hill 345 kV Line
- Missile Site – Smoky Hill & Missile Site – Daniels Park 345 kV Lines
- Missile Site – Pawnee 345 kV 1&2 345 kV Lines

Benchmark – Loss of Missile Site-Smoky Hill 345 kV Line

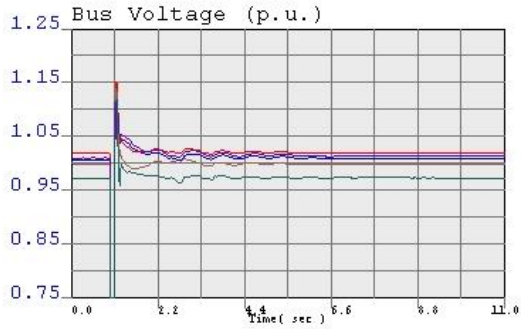

```

1.0000 | Bus | 1101 | MISS 345 11.0 | 1 | 1.0 | 1.0000 | 1 | 1.0000
1.0000 | Bus | 1102 | MISS 345 11.0 | 1 | 1.0 | 1.0000 | 1 | 1.0000
1.0000 | Bus | 1103 | MISS 345 11.0 | 1 | 1.0 | 1.0000 | 1 | 1.0000
1.0000 | Bus | 1104 | MISS 345 11.0 | 1 | 1.0 | 1.0000 | 1 | 1.0000

```

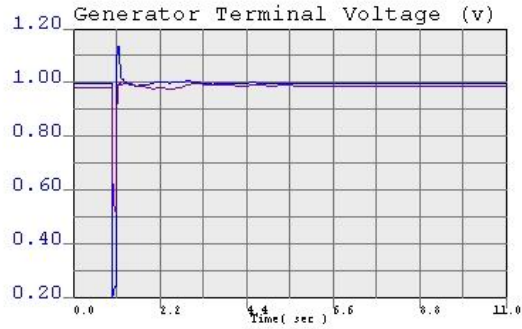

```

1.0000 | Bus | 1101 | MISS 345 11.0 | 1 | 1.0 | 1.0000 | 1 | 1.0000
1.0000 | Bus | 1102 | MISS 345 11.0 | 1 | 1.0 | 1.0000 | 1 | 1.0000

```

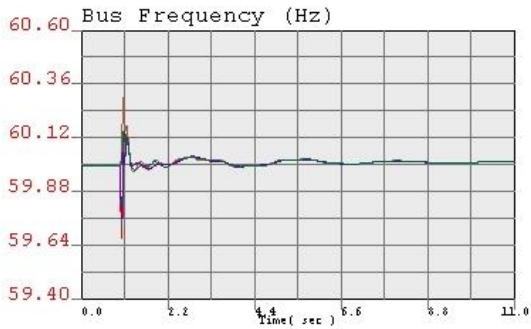

```

1.0000 | Bus | 1101 | MISS 345 11.0 | 1 | 1.0 | 1.0000 | 1 | 1.0000
1.0000 | Bus | 1102 | MISS 345 11.0 | 1 | 1.0 | 1.0000 | 1 | 1.0000
1.0000 | Bus | 1103 | MISS 345 11.0 | 1 | 1.0 | 1.0000 | 1 | 1.0000
1.0000 | Bus | 1104 | MISS 345 11.0 | 1 | 1.0 | 1.0000 | 1 | 1.0000

```

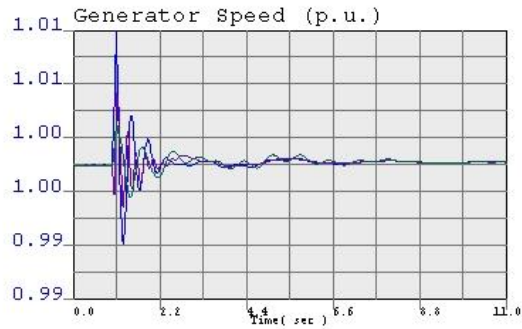

```

1.0000 | Bus | 1101 | MISS 345 11.0 | 1 | 1.0 | 1.0000 | 1 | 1.0000
1.0000 | Bus | 1102 | MISS 345 11.0 | 1 | 1.0 | 1.0000 | 1 | 1.0000
1.0000 | Bus | 1103 | MISS 345 11.0 | 1 | 1.0 | 1.0000 | 1 | 1.0000

```

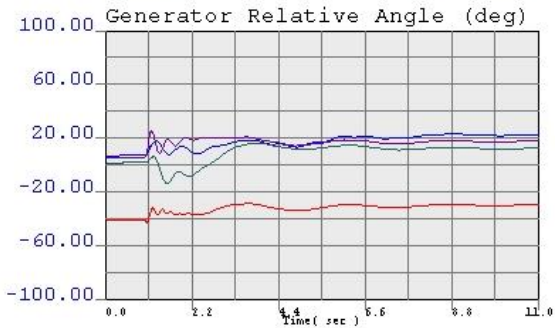

```

-0.0000 | Bus | 1101 | MISS 345 11.0 | 1 | 1.0 | 1.0000 | 1 | 1.0000
-0.0000 | Bus | 1102 | MISS 345 11.0 | 1 | 1.0 | 1.0000 | 1 | 1.0000
-0.0000 | Bus | 1103 | MISS 345 11.0 | 1 | 1.0 | 1.0000 | 1 | 1.0000
-0.0000 | Bus | 1104 | MISS 345 11.0 | 1 | 1.0 | 1.0000 | 1 | 1.0000

```

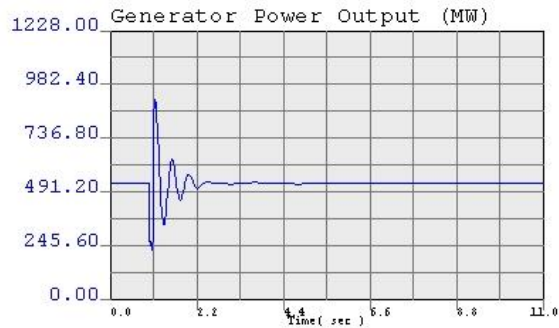

```

1.0000 | Bus | 1101 | MISS 345 11.0 | 1 | 1.0 | 1.0000 | 1 | 1.0000

```

Missile-Smoky
Missile Site-Smoky Hill 345 kV line





Benchmark – Loss of Missile Site-Smoky Hill & Missile Site-Daniels Park 345 kV Lines

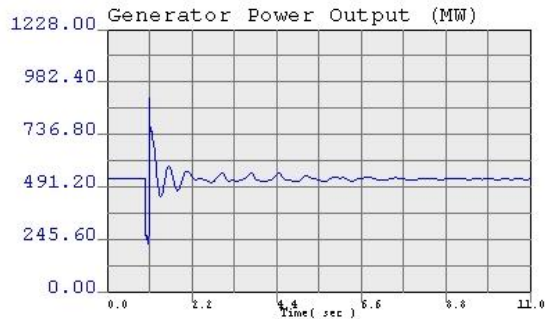
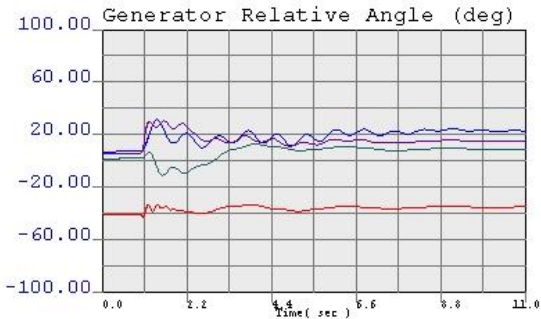
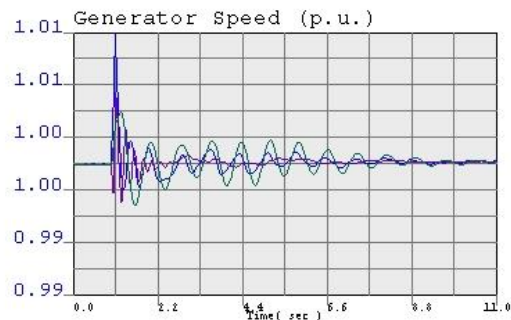
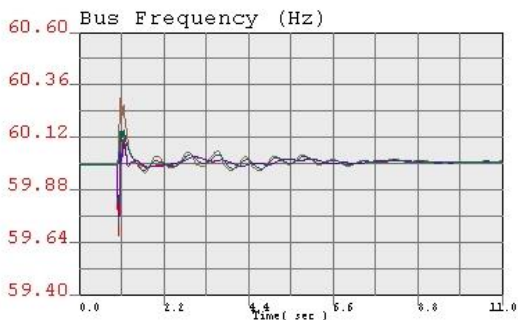
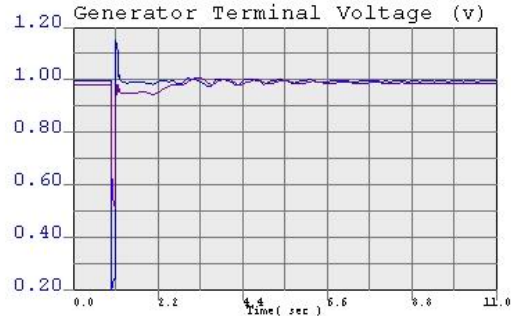
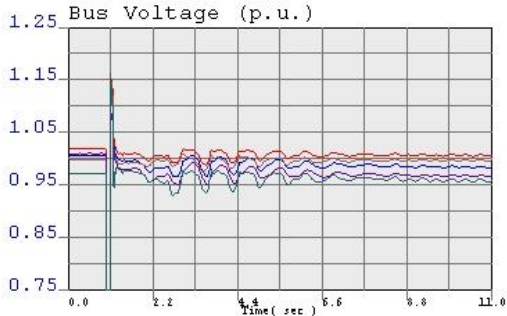

DCTL_Missile-Smoky-D
Missile-Smoky & Daniels 345 kV line



BM-DCTL_Missile-Smoky-D.chf



Benchmark – Loss of Missile Site-Pawnee 345 kV 1&2 Lines

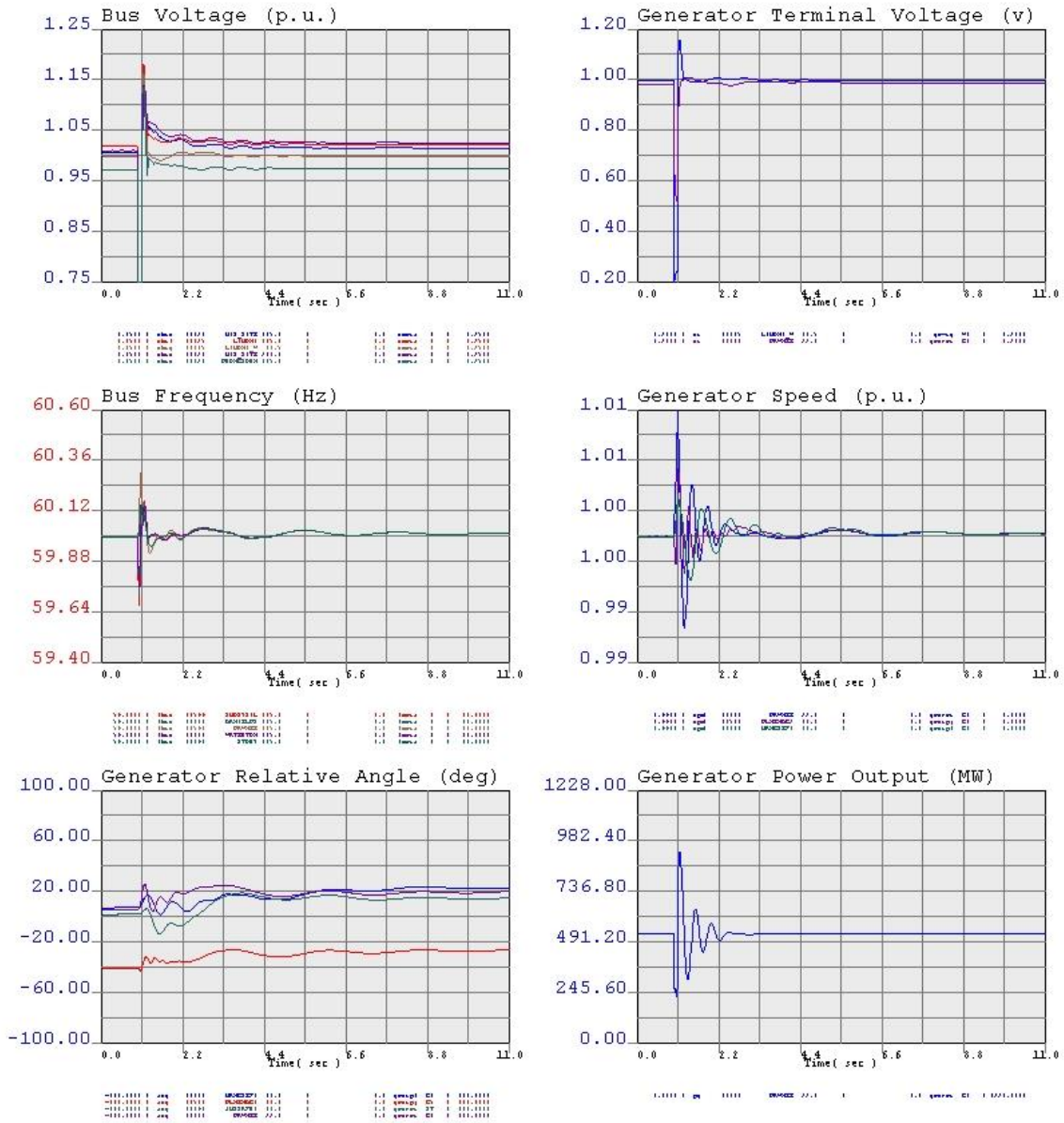

DCTL Missile-Pawnee
Missile-Pawnee 1&2 345 kV DCTL





Study Case – Loss of Missile Site-Smoky Hill 345 kV Line

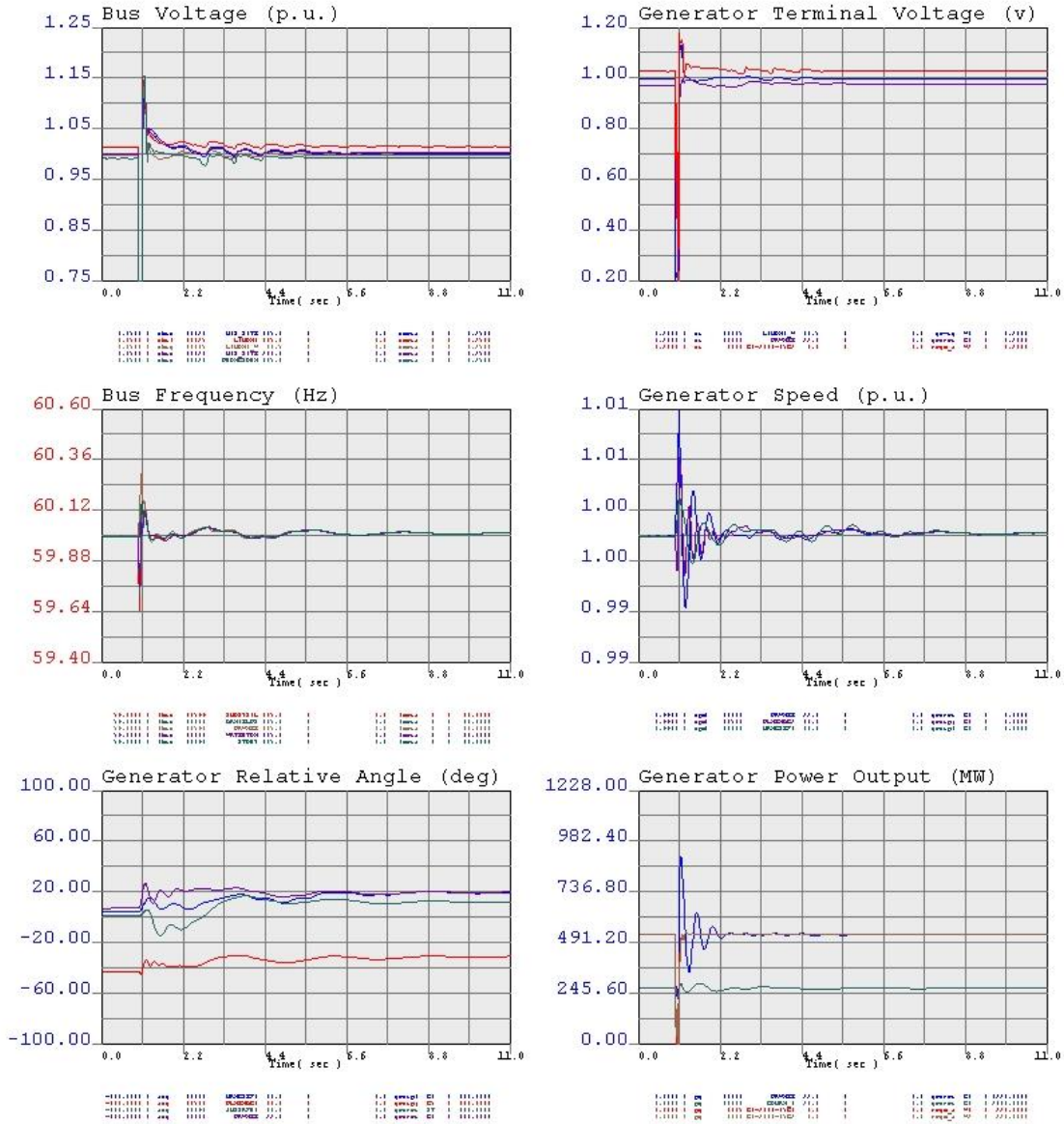

Missile-Smoky
Missile Site-Smoky Hill 345 kV line



Study Case – Loss of Missile Site-Smokey Hill & Missile Site-Daniels Park 345 kV Lines

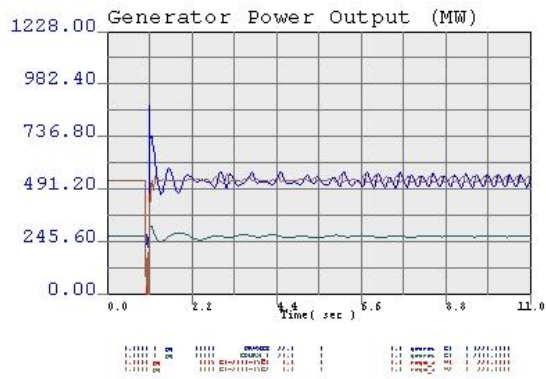
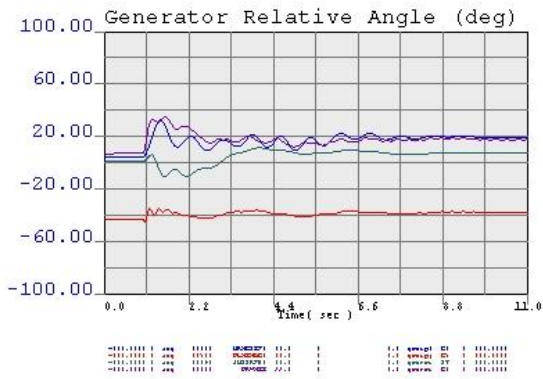
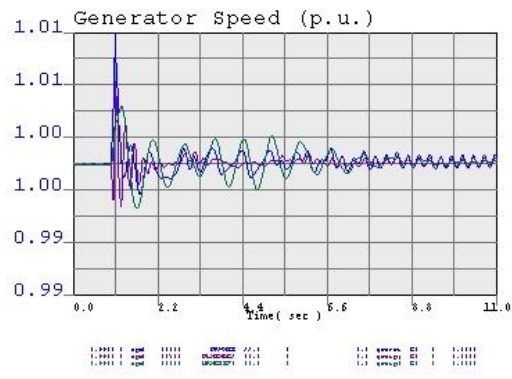
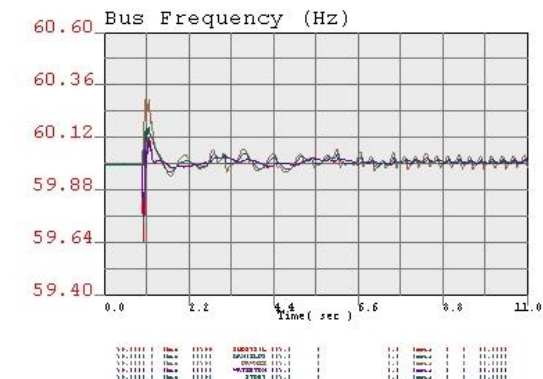
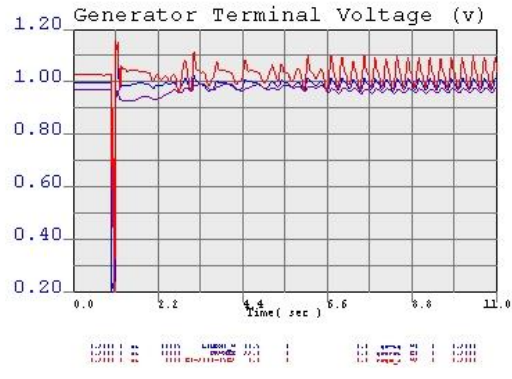
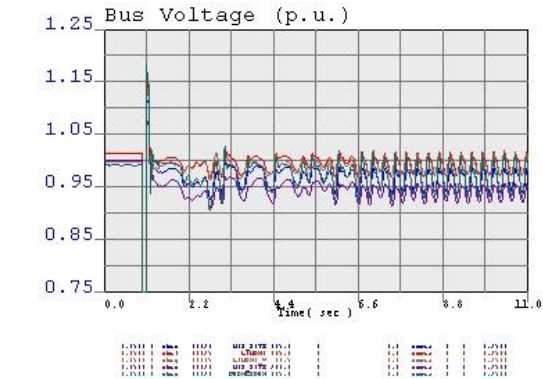

DCTL_Missile-Smokey-D
Missile-Smokey & Daniels 345 kV line



ST-DCTL_Missile-Smokey-D.chf



Study Case – Loss of Missile Site-Pawnee 345 kV 1&2 Lines

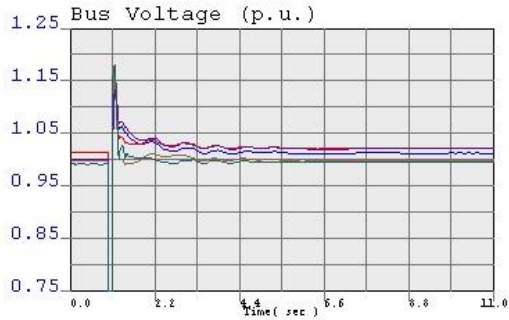

```

1.0000 | Bus | 1101 | BUS1 | 11.0 | 1 | 1.0 | 1.0 | 1.0000
1.0000 | Bus | 1102 | BUS2 | 11.0 | 1 | 1.0 | 1.0 | 1.0000
1.0000 | Bus | 1103 | BUS3 | 11.0 | 1 | 1.0 | 1.0 | 1.0000
1.0000 | Bus | 1104 | BUS4 | 11.0 | 1 | 1.0 | 1.0 | 1.0000
1.0000 | Bus | 1105 | BUS5 | 11.0 | 1 | 1.0 | 1.0 | 1.0000
  
```

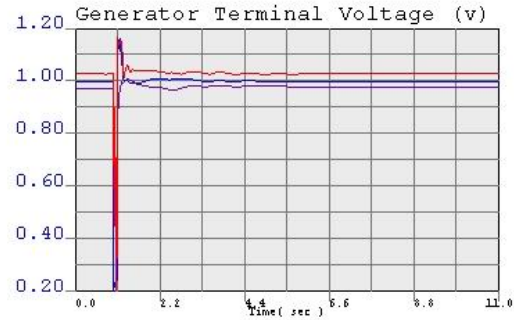

```

1.0000 | Gen | 1101 | GEN1 | 11.0 | 1 | 1.0 | 1.0 | 1.0000
1.0000 | Gen | 1102 | GEN2 | 11.0 | 1 | 1.0 | 1.0 | 1.0000
1.0000 | Gen | 1103 | GEN3 | 11.0 | 1 | 1.0 | 1.0 | 1.0000
  
```

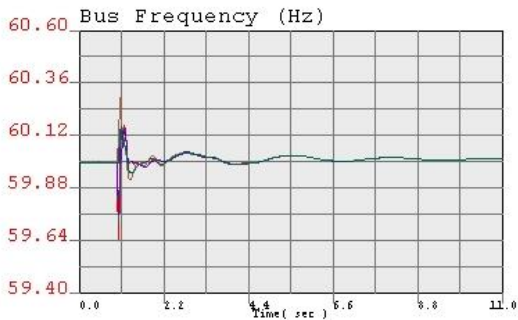

```

59.9999 | Bus | 1101 | BUS1 | 11.0 | 1 | 1.0 | 1.0 | 59.9999
59.9999 | Bus | 1102 | BUS2 | 11.0 | 1 | 1.0 | 1.0 | 59.9999
59.9999 | Bus | 1103 | BUS3 | 11.0 | 1 | 1.0 | 1.0 | 59.9999
59.9999 | Bus | 1104 | BUS4 | 11.0 | 1 | 1.0 | 1.0 | 59.9999
59.9999 | Bus | 1105 | BUS5 | 11.0 | 1 | 1.0 | 1.0 | 59.9999
  
```

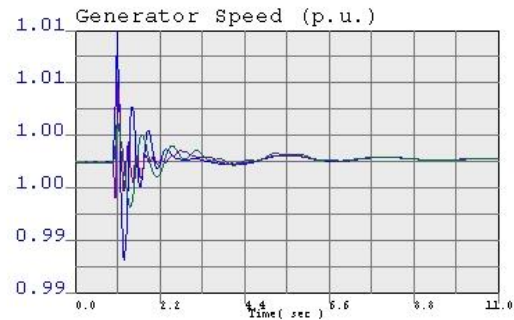

```

1.0000 | Gen | 1101 | GEN1 | 11.0 | 1 | 1.0 | 1.0 | 1.0000
1.0000 | Gen | 1102 | GEN2 | 11.0 | 1 | 1.0 | 1.0 | 1.0000
1.0000 | Gen | 1103 | GEN3 | 11.0 | 1 | 1.0 | 1.0 | 1.0000
  
```

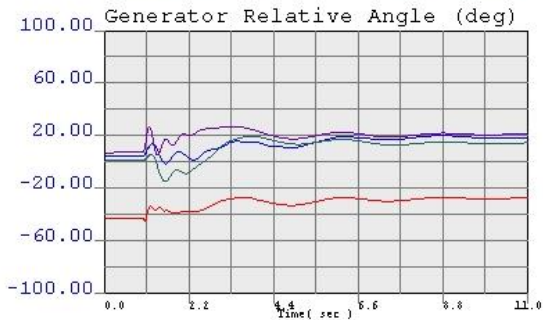

```

-111.1111 | Gen | 1101 | GEN1 | 11.0 | 1 | 1.0 | 1.0 | -111.1111
-111.1111 | Gen | 1102 | GEN2 | 11.0 | 1 | 1.0 | 1.0 | -111.1111
-111.1111 | Gen | 1103 | GEN3 | 11.0 | 1 | 1.0 | 1.0 | -111.1111
  
```

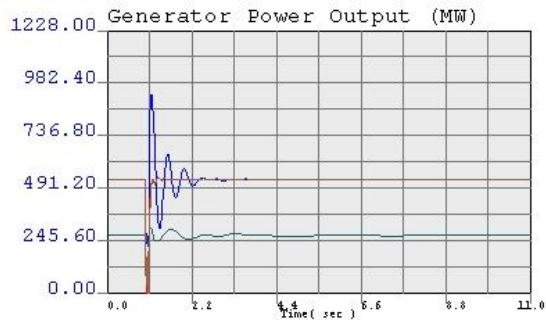

```

1.0000 | Gen | 1101 | GEN1 | 11.0 | 1 | 1.0 | 1.0 | 1.0000
1.0000 | Gen | 1102 | GEN2 | 11.0 | 1 | 1.0 | 1.0 | 1.0000
1.0000 | Gen | 1103 | GEN3 | 11.0 | 1 | 1.0 | 1.0 | 1.0000
  
```

DCTL_Missile-Pawnee
Missile-Pawnee 1&2 345 kV DCTL





Study Case w/ 400 MVAR capacitors – Loss of Missile Site-Smoky Hill 345 kV Line

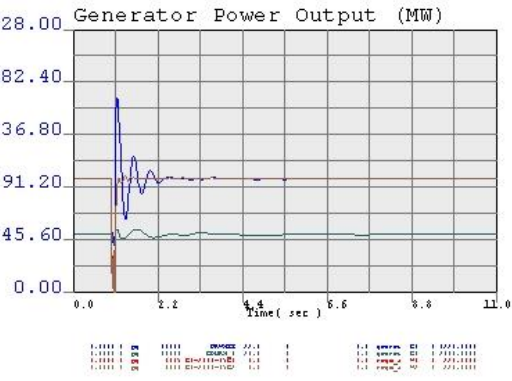
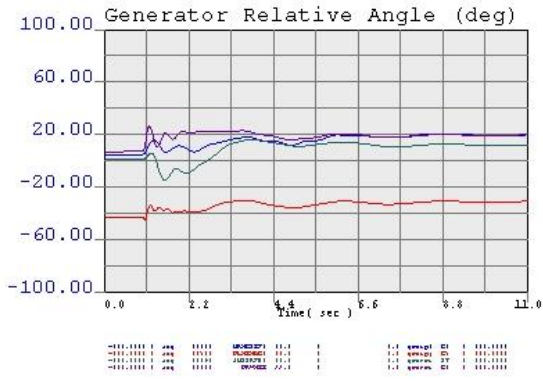
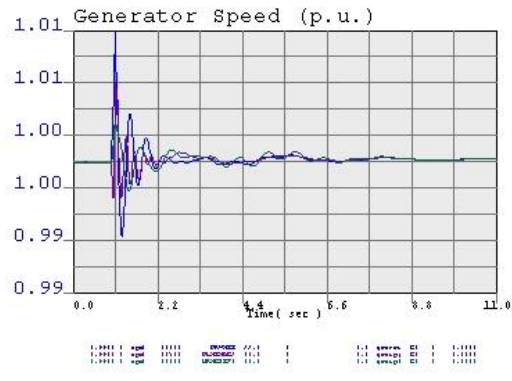
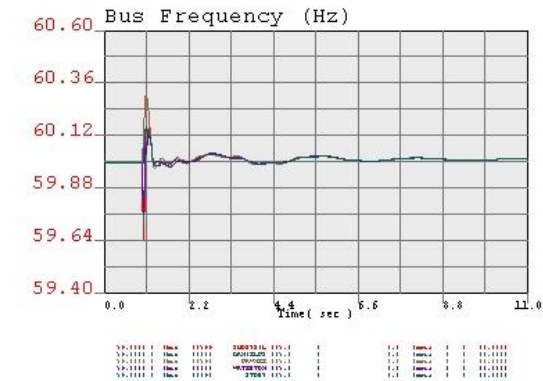
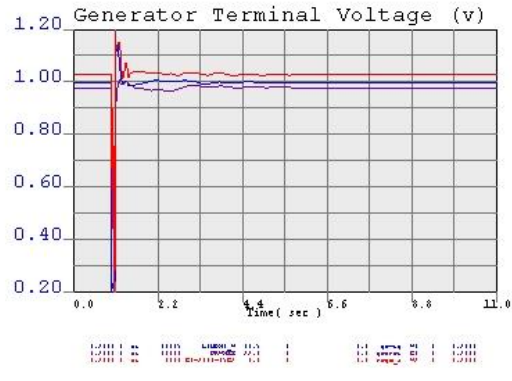
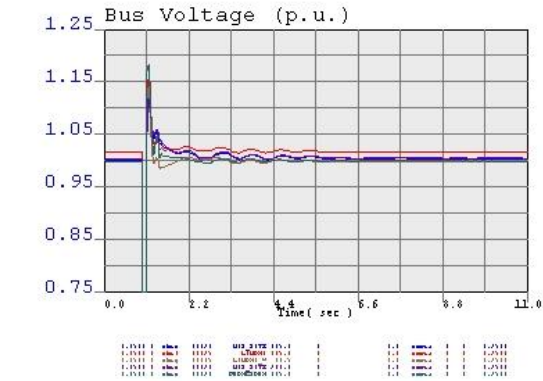

Missile-Smoky
Missile Site-Smoky Hill 345 kV line



ST_cap130-Missile-Smoky.chf



Study Case w/ 400 MVAR capacitors – Loss of Missile Site-Smoky Hill & Missile Site-Daniels Park 345 kV Lines

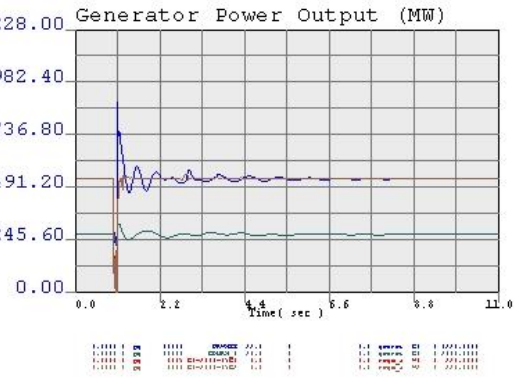
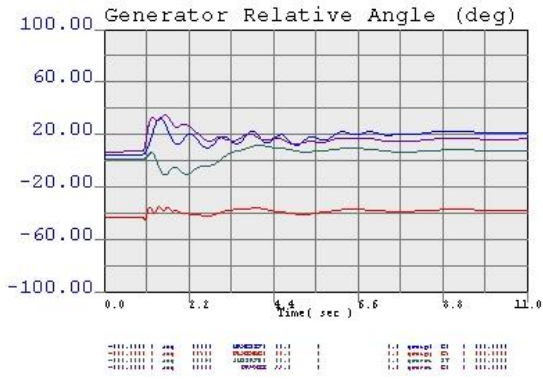
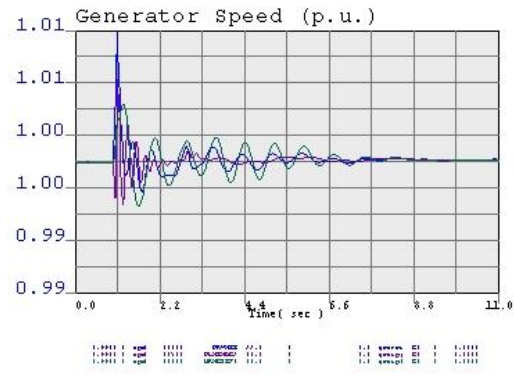
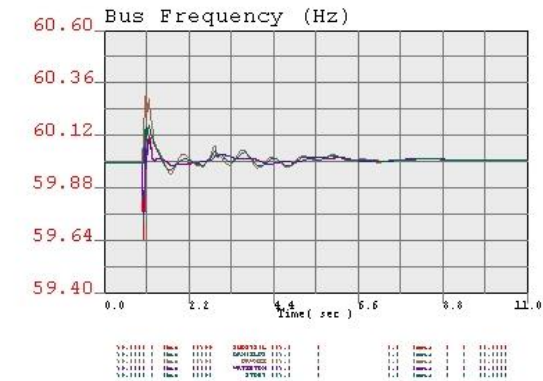
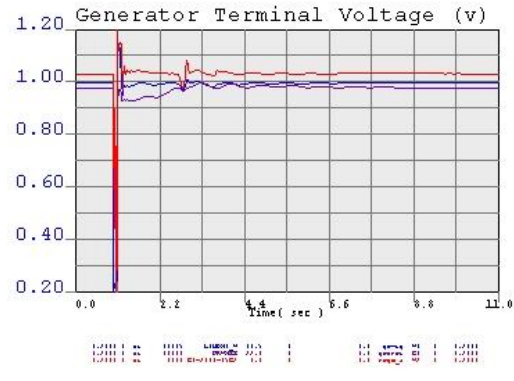
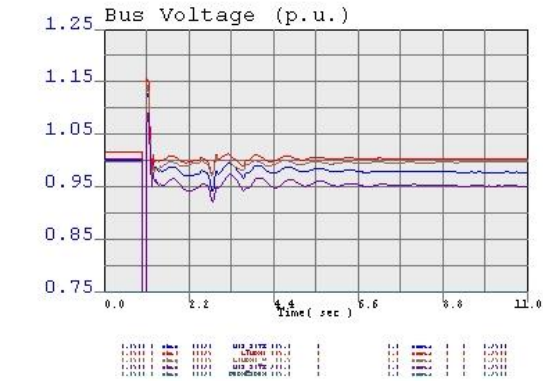

DCTL_Missile-Smoky-D
Missile-Smoky & Daniels 345 kV line



ST_cap130-DCTL_Missile-Smoky-D.chf



Study Case w/ 400 MVAR capacitors – Loss of Missile Site-Pawnee 345 kV 1&2 Lines

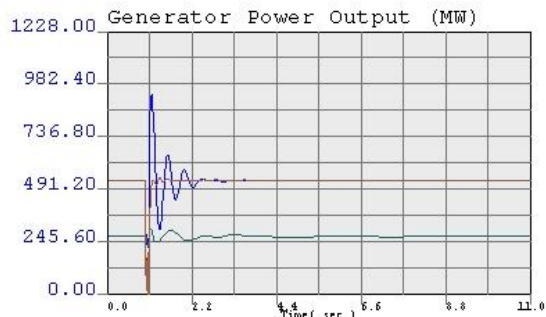
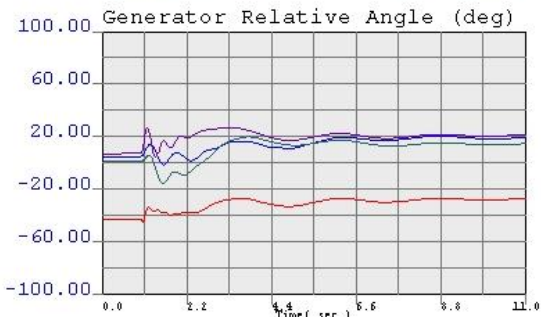
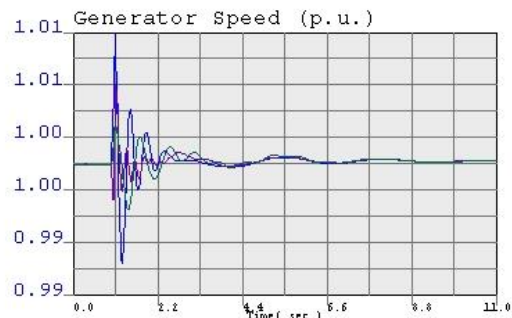
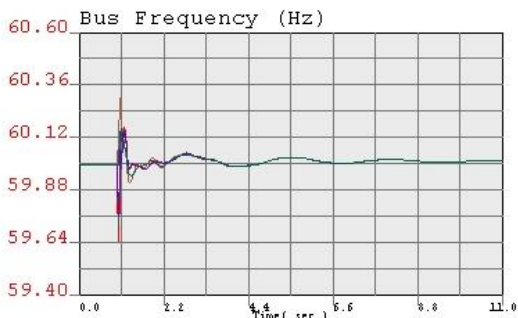
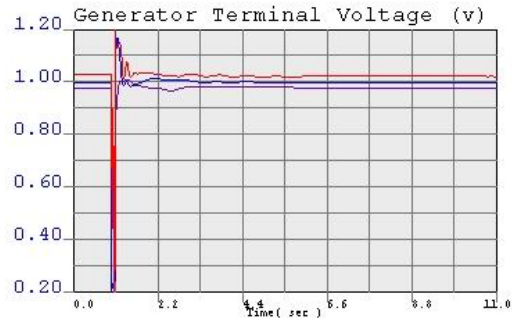
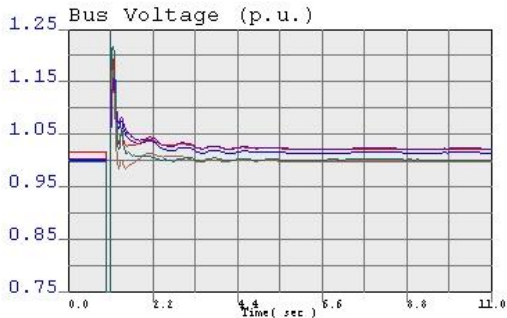

DCTL_Missile-Pawnee
Missile-Pawnee 1&2 345 kV DCTL



ST_cap130vtrip-DCTL_Missile-Pawnee.chf